

OPERATING MANUAL

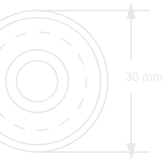

LIMIT

Precision Made Easy



30 mm



20°

CB 83/20
1 90/20
113/20
C 73/20

35 RPM

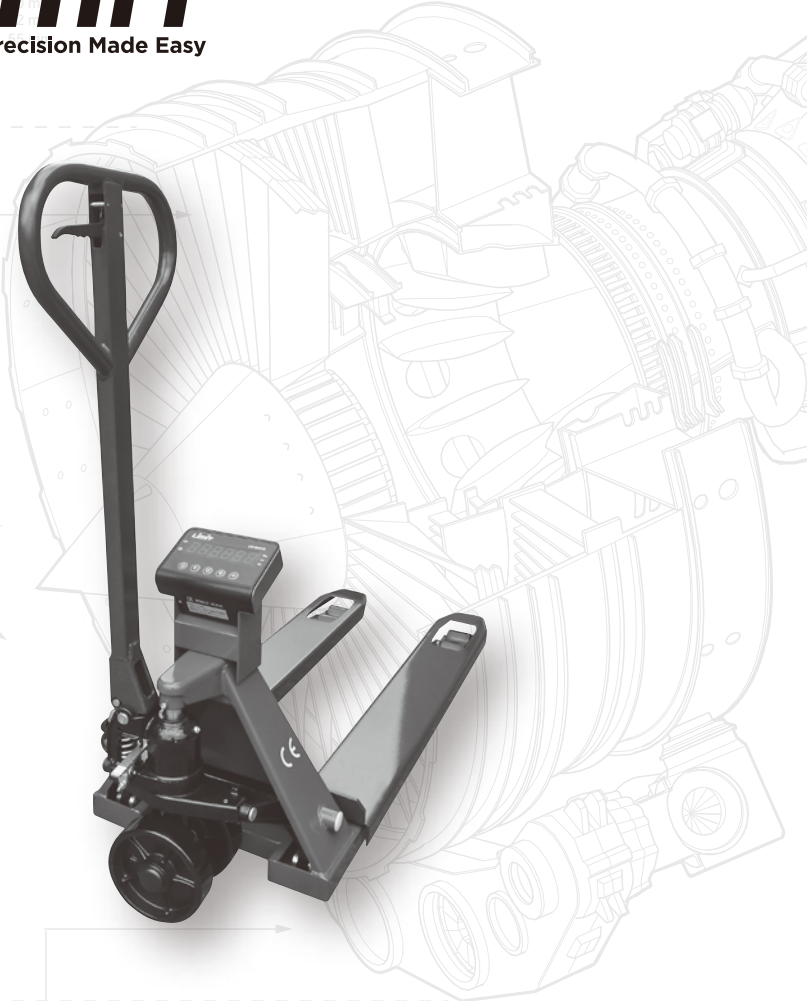
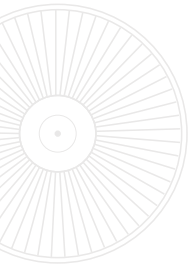

Mobile Scale

Limit LLW

80/50

80/50

83/20
90/20

FUNCTIONS

- Standard: Weighing function with zero, tare, hold and accumulation
- Optional: Counting function, animal weighing, check weighing, percentage weighing. (See technical manual)

KEYS AND FUNCTION/STATUS INDICATIONS ON THE SCALE DISPLAY







- Meaning/status of LED symbols

Symbol	Meaning	Status
~	Indicates whether the scale is stable or not.	Indicated if the scale is not stable.
→0←	Zero point indication.	Indicated if the zero point is within $\pm 0.2d$, otherwise off.
NET	Indicates whether the scale is in gross or net mode	Indicated when the scale is in net mode (tared) and off when the scale is in gross mode.
lb kg	Weight unit	Indicates which weight unit is active.
HOLD	HOLD function indication	Indicated when the function is active.
CHARGING	Battery and charging indication.	The green LED lights up when the battery and charger voltage is normal, and lights up red when the battery needs recharging or is being charged.



- Key functions

Unless stated otherwise, give the keys a short press.

Key symbol	Normal weighing mode	Comment
	Short press → Activate HOLD function Long press → Open menu system	Only works if the HOLD function is activated.

	Accumulation key Short press → Add weight Long press → Check total weight	Works if accumulation (or any of the different functions) is active.
	Switch between weight units.	kg as standard.
	Reset the tared value.	
	Tare key. Chain taring is possible up to 100%.	
	Zero the scale. Scale must not be loaded.	
	Short press → Switch the scale ON. Long press → Switch the scale OFF.	Short press to print if printer is installed.

To save battery power, the scale enters energy saving mode after 5 min. The display then shows a random character in the display after the last weighing operation. After a further 10 minutes, the scale switches off and must be restarted.

		Warning
	Warning	
Switch off the indicator and wait 3 seconds before switching on the charger power supply.		

FUNKTIONER

- Standard: Vägningfunktion med nollställning och tarering, hold & summering
- Valbart: Räknefunktion, djurvägning, checkvågning, procentvågning. (Se teknisk manual)

KNAPPAR OCH INDIKERING AV FUNKTION/STATUS PÅ VÅGDISPLAY

- Betydelse/status av LED symboler

Symbol	Analys	Orsak.
~	Indikerar om vågen är stabil eller ej.	Indikeras om vågen ej är stabil.
→0←	Indikering av nollpunkt.	Indikeras om nollpunkten är inom $\pm 0.2d$, annars släckt.
NET	Indikerar om vågen är i gross eller netto läge	Indikeras när vågen är i netto läge (tarerad) och släckt när vågen är i gross läge.
lb kg	Viktenhet	Indikeras vilken viktenhet som är aktiv.
HOLD	Indikering HOLD funktion	Indikeras när funktionen är aktiv.
CHARGING	Batteri- och laddnings indikering.	Den gröna lysdioden lyser när batteriets och laddarens spänning är normal, och den lyser rött när batteriet behöver laddas eller om den laddas.



- Knappfunktioner

Om inte annat refereras så är det korta knapptryckningar som gäller.

Knapp symbol	Normalt vägningläge	Anmärkning
	Kort tryck → Aktivera HOLD-funktion Långt tryck → Öppna menysystem	Fungerar bara om HOLD funktionen är aktiverad.

	Summerings knapp Kort tryck → Addera vikt Långt tryck → Kontrollera totalvikt	Fungerar om summering (eller någon av de olika funktionerna) är aktiv.
	Växla mellan viktenhet.	kg som standard.
	Nollställer tarerat värde.	
	Tar knapp. Kedjetarering är möjlig upp till 100%.	
	Nollställer vågen. Våg skall ej vara belastad.	
	Kort tryck → Starta vågen Långt tryck → Stäng av vågen	Printfunktion med kort tryck om printer är installerad.

För att spara batteri så går vågen ner i energisparläge efter 5 min. Displayen visar då slumpmässigt ett tecken i displayen, efter sista vägningen. Efter ytterligare 10 minuter stängs vågen av. Och måste startas om igen.

		Varning
	Varning	
Stäng av indikatorn och vänta 3 sek. innan nätspänning för laddning kopplas på.		

FUNKSJONER

- Standard: Veiefunksjon med nullstilling og tarering, hold og summering
- Tilvalg: Regnefunksjon, dyreveiing, kontrollveiing, prosentregning. (Se teknisk håndbok)

NO

KNAPPER OG INDIKERING AV FUNKSJON/STATUS PÅ VEKTDISPLAY

- Betydning/status for LED-symboler

Symbol	Analyse	Årsak
~	Indikerer om vekten er stabil eller ikke.	Indikeres hvis vekten ikke er stabil.
→0←	Indikering av nullpunkt.	Indikeres hvis nullpunktet er innenfor $\pm 0.2d$, ellers slukket.
NET	Indikerer om vekten er i gross eller netto modus	Indikeres hvis vekten er i netto modus (tarert) og slukket når vekten er i gross modus.
lb kg	Vektenhet	Indikerer hvilken vektenhet som er aktiv.
HOLD	Indikering HOLD-funksjon	Indikeres når funksjonen er aktiv.
CHARGING	Batteri- og ladeindikering.	Den grønne lysdioden lyser når batteriets og laderens spenning er normal, og den lyser rødt når batteriet må lades eller hvis det lades.

- Knappefunksjoner



Med mindre annet er angitt, er det korte knappetrykk som gjelder.

Knappesymbol	Normal veiemodus	Anmerkning
	Kort trykk → Aktiver HOLD-funksjon Langt trykk → Åpne menysystem	Fungerer bare når HOLD-funksjonen er aktivert.

	Summeringsknapp Kort trykk → Adder vekt Langt trykk → Kontroller totalvekt	Fungerer hvis summering (eller noen av de ulike funksjonene) er aktiv.
	Veksle mellom vektenheter.	kg er standard.
	Nullstiller tarert verdi.	
	Tarapknapp. Kjedetarering er mulig opp til 100%.	
	Nullstiller vekten. Vekten må ikke være belastet.	
	Kort trykk → Start vekten Langt trykk → Slå av vekten	Utskriftsfunksjon med kort trykk hvis skriver er installert.

NO

For å spare batteri går vekten til energisparemodus etter 5 minutter. Da viser displayet et vilkårlig tegn, etter siste veiing. Etter ytterligere 10 minutter slås vekten av. Og den må startes på ny.

		Advarsel
	Advarsel	
Slå av indikatoren og vent i 3 sekunder før du slår på nettspenning til lading.		



AB 60 mm
 LD 12 mm
 C1 55 mm

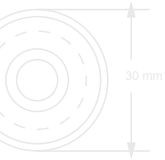

CB 83/20
 1 90/20
 2 113/20
 C 73/20

35 RPM

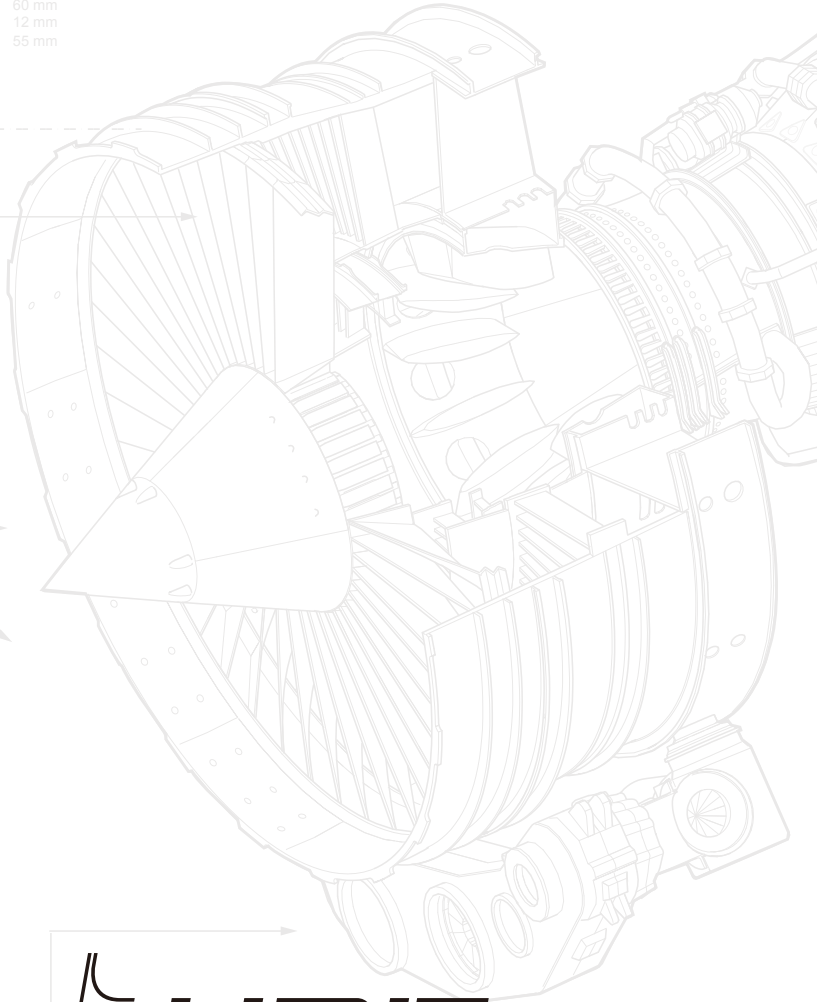
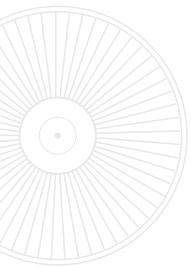

LIMIT

Precision Made Easy

80/50

80/50

+46 322-60 60 00

info@limit.se

limit-tools.com

83/20
 90/20